

# Tarkett Traditional Wall Base

Tarkett has the industry's most extensive offering of traditional wall base. Whether it be straight base, cove base, rubber or vinyl - we are able to match any combination of aesthetic, performance and formulation to meet the needs of your project.

## TRADITIONAL WALL BASE SYSTEM

FINISHING BORDERS

### Keep It Simple

We know there's a time and a place for straightforward, no-nonsense options. That's why our Traditional Wall Base is basic, but better. With durable construction and multiple options for height and color, our Traditional Wall Base has everything you need. And nothing you don't.

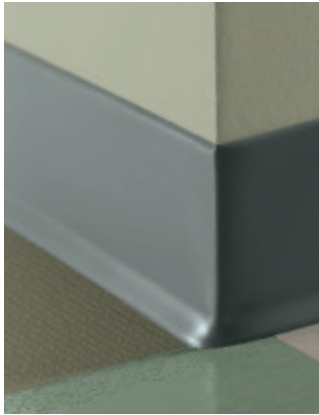

TRADITIONAL

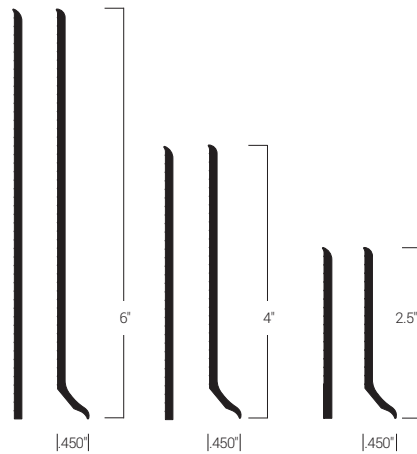

Available in Dura-Cove® Rubber (type TP) 1/8" (3.175 mm) and vinyl (type TV) .080" (2 mm) or 1/8" (3.175 mm)

Standard heights available in toe or toeless

4' sections and coils available

Manufactured inside and outside corners available

4.5", 8", 9" and 10" heights are special order; contact your local Tarkett representative

4.5" in Dura-Cove only

#### 3 Standard Heights:

2.5" (64 mm),  
4" (102 mm) or  
6" (153 mm) or 4.5" (114 mm) in DC only

**Recycled Content:** Pre-consumer 14%

**See Adhesives** pg. 616

# BASEWORKS® THERMOSET RUBBER WALL BASE

## FINISHING BORDERS

A natural fusion of aesthetics, performance and sustainability, BaseWorks® rubber wall base delivers pure, uniform color and an attractive matte finish. Its flexibility makes installation quick, easy and inexpensive. Plus, it won't fade, crack or separate from the wall.



	TV Thermoplastic Vinyl*	TP Thermoplastic Rubber	TS Thermoset Rubber*
Phthalate Free	✓	✓	✓
Bio-Based Content			✓
100% Recyclable	✓	✓	✓
10%+ Recycled Content	✓	✓	
Material Assessment Cradle to Cradle Certified <sup>SM</sup> V.3 Silver			✓
ColorMatch <sup>®</sup>	✓	✓	✓
No Dye Lots	✓	✓	✓

\*Not available in Metallics

### Tarkett Wall Bases. Tie it together.

The connecting space between wall and floor presents an opportunity to add color, pattern, clean lines, lasting protection – or all of the above. With the most comprehensive collection of wall borders in the country, we make it easy to unify your space with the perfect finishing touch.

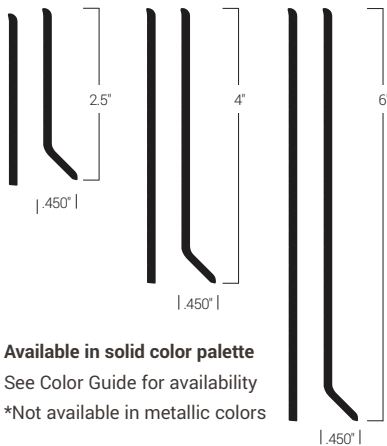

Thermoset rubber (type TS) 1/8" (3.175 mm)  
Standard heights available in toe or toeless  
4' sections and coils available  
Manufactured inside and outside corners available

#### 3 Standard Heights:

2.5" (64 mm),  
4" (102 mm) or  
6" (153 mm)

**Recycled Content:** Pre-consumer 14%

**See Adhesives** pg. 616

# PERCEPTIONS®

## FINISHING BORDERS

### Perceptions Designer Wall Base

Achieve the look of Millwork with a cost similar to standard wall base. Perceptions offers more than 115 colors and five standard profiles designed to coordinate with our Millwork Wall Finishing System. So adding architectural flair has never been easier (or more cost-effective).

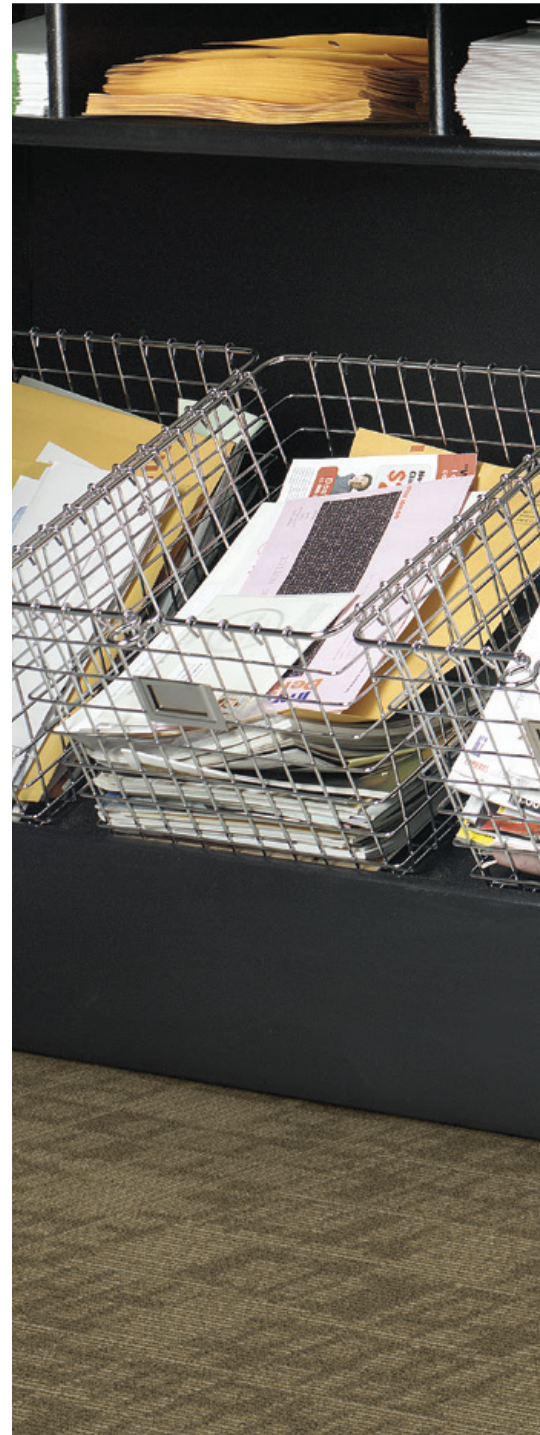
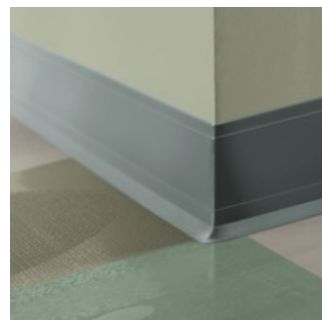
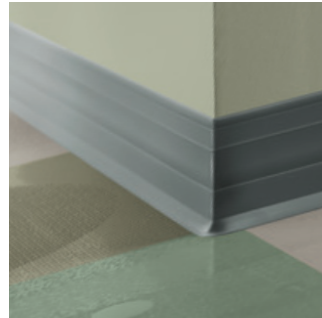
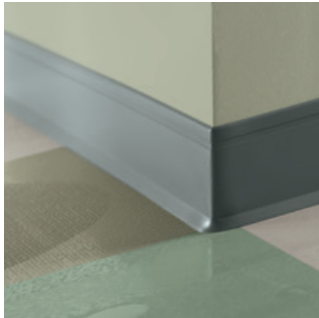
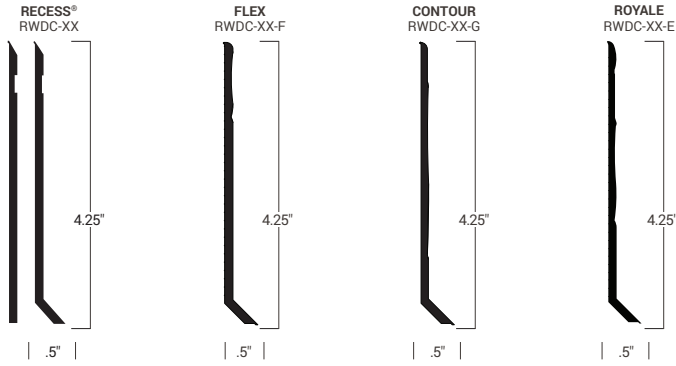



# TIGHTLOCK® WALL BASE SYSTEM

## Lock It

When we say TightLock® Carpet Base comes first, it really does. Its notched design allows it to be installed before the carpeting and carpet tile, and remain in place when changing out the flooring too. This saves time and money on re-installation and wall repairs. Plus, this durable, high-performance base can stay in place longer, making it a more sustainable choice. Also available in a Resilient Base, TightLock provides a cove base look with a more subtle radius. With a unique tapered design, the resilient base accommodates any commercial flooring and delivers a tight, clean, finished appearance year after year.



TIGHTLOCK CARPET

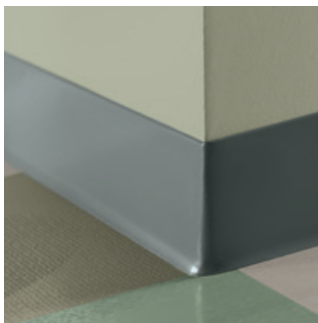
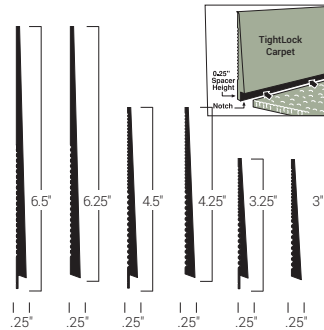

TIGHTLOCK RESILIENT

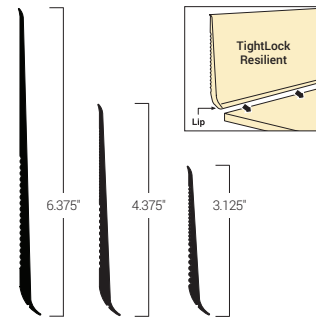

3 standard heights: 2.5" (64 mm), 4" (102 mm), 6" (153 mm) or 4.5" (114 mm) inDC only

Available in Dura-Cove® Rubber (type TP) 1/8" (3.175 mm) and vinyl (type TV) .080" (2 mm) or 1/8" (3.175 mm)

Standard heights available in toe or toeless

4' sections and coils available

Manufactured inside and outside corners available

4.5", 8", 9" and 10" heights are special order; call for details

4.5" in Dura-Cove only

**TightLock for carpet:**

3.25" (83 mm), 3" (76 mm) face  
4.5" (114 mm), 4.25" (108 mm) face  
6.5" (165 mm), 6.25" (159 mm) face

**TightLock for resilient flooring:**

3.125" (79 mm)  
4.375" (111 mm)  
6.375" (162 mm)

**Recycled Content:** Pre-consumer 14%

**See Adhesives** pg. 616

# SOLID COLORS

COLORMATCH®

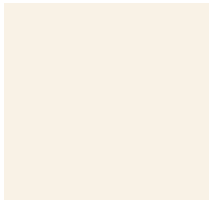

01  
SNOW WHITE W



24  
GREY HAZE WG



55  
SILVER GREY WG



32  
PEBBLE WG



29  
MOON ROCK WG

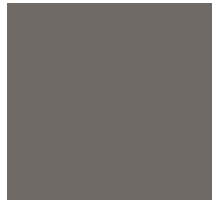

48  
GREY WG



21  
PLATINUM CG



38  
PEWTER CG



28  
MEDIUM GREY CG



20  
CHARCOAL WG



63  
BURNT UMBER B



40  
BLACK B



34  
ALMOND W



22  
PEARL CB



31  
ZEPHYR CB



80  
FAWN CB



09  
CLAY WB



49  
BEIGE WB



45  
SANDALWOOD WB



283  
TOAST



129  
SILK WB



11  
CANVAS WB



42  
SABLE WB



76  
CINNAMON



130  
SISAL



132  
ESPRESSO



85  
BURGUNDY



47  
BROWN



150  
WETLANDS



86  
HUNTER GREEN



167  
FUDGE



44  
DARK BROWN B



71  
STORM CLOUD CG



58  
WINDSOR BLUE



92  
BLUE LAGOON



18  
NAVY BLUE

## ColorMatch®

ColorMatch is a designer palette of 36 leading colors that offer coordinating colors across multiple products with no dye lots...ever! Our rigorous manufacturing and quality standards enable you to confidently mix and match a color across all Tarkett rubber and vinyl flooring products, finishing borders and finishing accessories.



# SOLID COLORS

## COLOR GUIDE

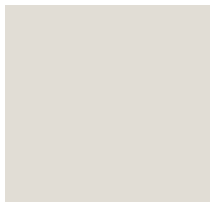

460  
COTTON W

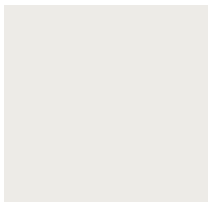

27  
MIST WG



TG5  
MACADAMIA WG



195  
ASH WG



23  
VAPOR GREY CG



199  
DOCKSIDE WG



TG6  
MINK WG



197  
SHADED WG

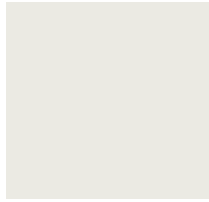

TG1  
SNOWBOUND W

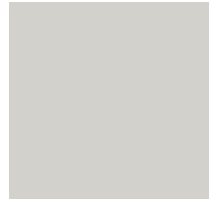

TB3  
DOVER CG



TG2  
SHARK FIN CG



TG3  
IRON MOUNTAIN CG



TA5  
COLONIAL GREY CG



262  
DRIZZLE CG



TA6  
BEDROCK CG



TG4  
BLACK MAGIC B

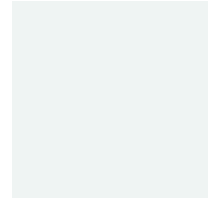

50  
WHITE W



469  
MYSTIFY CG



168  
THUNDER



TA4  
GATEWAY WG

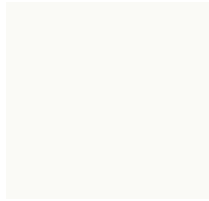

08  
ICICLE W



12  
HARD ROCK WB



121  
CEMENT CB



TA8  
WELSH CASTLE CB



TA3  
CASTAWAY CB



280  
SHORELINE



281  
GRIZZLY CB



101  
SEAWEED

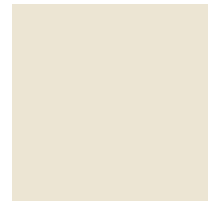

79  
BONE WHITE W



461  
WICKER WB



194  
ANTIQUÉ WHITE W



107  
NEUTRALITY

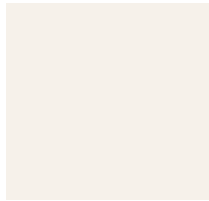

68  
WHITE SAND W



TA1  
TANNERY WB



TA2  
SADDLEBROOK WB



149  
MILK CHOCOLATE

# SOLID COLORS

## COLOR GUIDE



**TB1**  
PEPPERCORN



**282**  
VAPORIZE



**276**  
MYSTICAL



**264**  
GROUNDED



**151**  
IGUANA



**TH1**  
GLENHAVEN



**190**  
GREEGE



**TB2**  
BOXWOOD



**59**  
HEATHER GREEN



**293**  
PEACOCK



**73**  
PALM LEAF



**72**  
HARBOUR



**41**  
SEA BREEZE



**192**  
TIDEWATER



**84**  
BLUE JEANS



**70**  
BLUEST



**106**  
SKINNY DIP



**83**  
MIDNIGHT



**TH3**  
INKWELL



**TA9**  
INDIGO



**TB4**  
GRAPEST



**TG9**  
POETRY PLUM



**162**  
SOVEREIGN



**14**  
TROPICAL STORM



**33**  
ADOBE PEACH



**113**  
CHESTNUTTY



**TA7**  
RUSTY NAIL



**TH2**  
BLUE INTENSITY



**TG7**  
CANARY



**62**  
TANGERINE TANGO



**TG8**  
SPICY CHIP



**TB6**  
FLAME



**284**  
GANACHE



**15**  
CABERNET



**163**  
SALSA

## METALLIC COLORS

COLOR GUIDE



77  
WHITE PEARL W



67  
OLD GOLD



176  
BRASS WB



66  
EITHER ORE



179  
STEEL WG



69  
STERLING SILVER CG



178  
IRONSTONE CG



82  
BLACK PEARL B

### **Metallics:**

The updated solid color palette includes eight metallic shades, providing another element of detail and visual interest to finish a space.

All colors shown in this section, including chips and photographs, approximate the actual flooring colors as accurately as possible.

# COLOR AVAILABILITY CHART

Chart indicates standard availability across all traditional Tarkett solutions.  
 Don't see the color you want in the product you need? Just ask. Put our customization to the test.

COLOR PALETTES					
	TARKETT SOLUTIONS	SOLID COLOR (Including ColorMatch®)	COLOR-MATCH ONLY	METALLICS	SPECIAL NOTES
WALL BASE SOLUTIONS	Dura-Cove® and Rubber Wall Base	•		•	4" Traditional Toe standard in Masquerade®.
	Vinyl Wall Base	•			
	Baseworks® Thermoset Rubber Wall Base	•			
	Perceptions®	•		•	
	TightLock®	•		•	4.5" TightLock Carpet, 4.25" TightLock Carpet (without Spacer ), 4.375" TightLock Resilient.
	Millwork Wall Base® (including Chair Rail, Corner Guard and Shoe Moulding)	•		•	All items are available in color 00 unfinished. This color does not require primer before being painted.
	Masquerade®				Standard in Reveal®, Classic, Silhouette®, Outline®, Oblique®, Traditional Rubber Toe Base, Quarter Round and Shoe Moulding.
FLOOR FINISHING ACCESSORIES	Floor Finishing Accessories		•		
	Slim Line Transitions		•	•	
RUBBER FLOORING SOLUTIONS	Rubber Tile ( <i>All textures</i> )	•			Prima® Marbleized and Prima Olio® are special order.
	Speckled Rubber Tile in 1/8" and 0.080" Tiles Triumph and Inertia Rubber				Please refer to Tarkett Product Guide or <a href="http://tarkettna.com">tarkettna.com</a> for the standard Speckled colorway offerings. Or, expand your options by using the color guide to create your own unique speckled pattern.
	Mesto® and Mesto Configurations Rubber Tile				Please refer to Tarkett Product Guide for the standard color offerings for Mesto Configurations rubber flooring. Custom colors by special request.
	Eco-Naturals CorkTones® Rubber Tile		•		Custom colors with cork are available by special request.
	Defiant® Oil & Grease Resistant Rubber Tile				Please refer to Tarkett Product Guide for the standard color offerings for Defiant Oil & Grease Resistant rubber flooring.
STAIRWELL SOLUTIONS	Rubber Stair Treads	•			Some profiles available in Speckled tile colorways as standard. Custom colors, Prima Marbleized and Olio patterns and Mesto colorways by special request.
	Rubber Stringers and Risers	•			
	Vinyl Treads, Stringers, Risers & Nosings		•		
	Slim Line Nosings		•	•	
<p><b>How to order:</b> Specify Texture Code below Swatch-Color Number-Gauge.                      For example, to order Rice Paper in color 49 Beige in 1/8" gauge, specify: FRPA - 49 - 1/8".</p>					